



SHERMAN

2004 SERVICE MANUAL

Sherman Slider Plus

Sherman Slider

Sherman Breakout Plus

Sherman Breakout

Sherman Firefly

Sherman Flick



28209 Avenue Stanford, Valencia, California 91355

661 257-4411 | fax 661 294-4179 | www.answerproducts.com

Table of Contents

Description	Page
Introduction	3
Front Suspension Terminology	4
Disassembly Instructions	8
Travel Adjust Systems: Rapid Travel II	11
Assembly Instructions	14
Bushing Removal and Installation Instructions	19
Troubleshooting Chart	23
Sherman Flick Schematic and Torque Specifications	25
Sherman Firefly Schematic and Torque Specifications	26
Sherman Breakout/Breakout + Schematic and Torque Specifications	27
Sherman Slider Schematic and Torque Specifications	28
Sherman Slider + Schematic and Torque Specifications	29
Sherman Service Kit Chart	30

Contact Information

Answer Products Customer Service Department
28209 Ave. Stanford
Valencia, CA 91355

Toll Free: (800) 423-0273
Direct: (661) 257-4411
FAX: (661) 775-1798
E-mail: warranty@answerproducts.com
tech@answerproducts.com

Web site: www.answerproducts.com





INTRODUCTION

This manual is intended to guide the user through basic service of Manitou Sherman front forks. Service is supported by the identification of common parts and assemblies that have been assembled into Service Kits. The purpose of this manual will be to describe conditions that may drive the need for service and to provide installation instructions for the kits.

Due to the time-consuming nature suspension fork service, at this time our primary focus is to offer service kits that minimize the amount of downtime and labor involved.

Important information is highlighted in this manual by the following notations:

WARNING

Failure to follow **WARNING** instructions could result in severe injury or death to the person inspecting or repairing the suspension fork or the user.

CAUTION

A **CAUTION** indicates special precautions that must be taken to avoid damage to the product.

NOTE

A **NOTE** provides key information to make procedures easier or clearer

GENERAL WARNING: Suspension forks by design contain gases and fluids under extreme pressure and warnings contained in this manual must be observed to reduce the possibility of injury or possible death. Following these instructions can help you reduce the risk of being injured. Any questions in regards to the information in this manual should be directed to Answer Products Customer Service at (661) 257-4411.

WARNING: The Sherman uses compressed air to provide fluid pressure in the damping system in some models. This system must be relieved of pressure prior to servicing these systems. Failure to relieve air pressure could result in injury or possible death.

CAUTION: The Sherman suspension fork uses precision machined aluminum and other soft alloy components. Using correct tools for assembly is essential to prevent damage.



GLOSSARY OF TERMS

Air Cap – Top cap that threads into top of air/spring leg (this is the left leg of the fork as you are seated on the seat). Forks may be controlled with an air/spring or a coil spring. The air cap contains the Schrader Valve, which is used to control the spring rate or SAG of air forks.

Air Spring – A mechanism that is used to control the SAG of an air fork.

Arch – A support that connects the two outer lower legs of the casting so as to keep them moving in unison.

Boss – The word used to describe an outer casting that has brake posts for V-brakes or cantilever brakes.

Bottom Out Bumper – A rubber or elastomer device that absorbs the shock that occurs when a suspension is compression to its limit.

Bushings – A cylindrical sleeve between a fork stanchion tube (inner leg) and a fork outer casting (slider), which facilitates the sliding movement between these two parts.

Coil Spring – A coiled piece of metal that acts as a spring to help suspend a fork.

Compression – The phase of the suspension operation in which the wheel travels up, or travels closer to the frame. The suspension forks reaction to a bump in the trail.

Compression Damping – Restriction of the rate that the suspension compresses under load.

Convertible Travel – A system used to alter the travel of a suspension fork. It requires moving a travel clip on the compression rod to a different position. This operation is accomplished by disassembling the fork and physically moving the travel clip on the compression rod.

Crown Steerer Assembly – the stanchion legs (inner legs), the fork crown, and the steer tube pressed together as one assembly. This assembly is then finished by adding all of the fork internals and then outer casting (slider).

Damping – A function that modifies the rate of suspension compression or rebound.

Detent – An indentation that causes a rotating adjuster to stop at fixed increments.

Drop Out – The end of an outer casting (slider) where the wheel attaches.

Dust Boot – Usually a piece of rubber in the shape of a cylinder with baffles to allow it to compress as the fork compresses through its travel. Its function is to help keep dirt and water from getting into the inner legs of the fork.

FFD – Fluid Flow Damping. A Manitou patented low cost oil damping system. The compression damping is non-adjustable and the rebound damping may be non-adjustable or adjustable damping.

GLOSSARY OF TERMS (CONT.)

Fork Crown – The component that joins the stanchion tubes (inner legs) to the steer tube of the fork.

Hydraulic Fork Oil – Oil used in suspension designs to provide damping. It has special characteristics that determine how it reacts when exposed to compressed air, how it changes viscosity when its temperature changes, and how it moves through valves.

Hydraulic Lock Out – a condition caused when the mixture of air and damping oil is out of balance. It is caused when there is too little air space in a chamber, not allowing the fork to compress through its travel.

Lock Out – a special function that restricts the compression of the fork from moving. It is generally controlled by an external knob that is activated when a rider does not want the fork to move, thus eliminating extra energy needed to overcome the bobbing forces of the fork.

MCU – (Micro-Cellular Urethane) Special urethane that is filled with tiny air cells that act like springs when the elastomer is compressed.

Micro Lube – Lubrication system that is operated by injecting small quantities of grease directly into ports that are inserted into outer casting legs. This enables the lubrication of the fork without having to disassemble it.

No Boss - The word used to describe an outer casting that has no brake posts for V-brakes or cantilever brakes. This casting is to be used for disk brakes only.

Oil Damping – A system that uses the resistance to oil flow through holes in a valve to provide a means to alter the rate of suspension compression or rebound.

Oil Level – The level of damping oil needed for the optimal damping performance of a suspension. It is measured as the air space distance between the top of the stanchion leg (inner leg) and the height of the oil inside of the leg. The fork must be completely extended in order to get an accurate measurement.

O-Ring – A soft, flexible neoprene or Buna rubber ring with a round cross-section, which is used for sealing and retention.

Oil Weight – A description of the relative viscosity of oil, such as hydraulic oil. Oil with low weight numbers (5wt or 7wt) flow through valves with less resistance than higher weight numbers (10 or 15 wt).

Outer Casting – (see Slider)

Preload – A condition of compressing a spring or elastomer before the operating loads are put on the suspension, so that it provides a stiffer spring rate.

Piston – In front suspension, the part of the damper that slides back and forth inside of the damping leg that houses the valves. It can also refer to the air piston in the air/spring assembly that slides back and forth compressing the air, thus causing a change in the spring rate of the suspension.



GLOSSARY OF TERMS (CONT.)

Porosity – The condition or property of having pores in a material that will allow gas or liquid to pass through it.

Rapid Travel I, II, Wind Down – Systems that are used to control the travel of suspension forks. Also known as RTI, RTII, and WD. RTI and RTII are used for the specific purposes of controlling the travel in two conditions: climbing and descending. WD is an incremental travel adjustment between to set limits and does not affect the spring rate of the fork as severely as RTI and RTII.

Rebound – The phase of the suspension operation in which the wheel returns to its original position on the ground after compression.

Rebound Damping – Restriction of the rate that the suspension rebounds when the compression load is relieved.

Reverse Arch Technology – Also known as RA. It is a system that is designed to move the arch of a fork to the backside of a fork, rather than the conventional front position. It was designed to provide greater rotational torque strength to an outer casting (slider), without adding additional weight to the fork.

SAG – The amount a suspension fork compresses at rest with a normal load (rider's weight).

Schrader Valve – Valve used to introduce air into a chamber.

Seal – A part, usually neoprene rubber or Buna, that keeps contaminants out and/or working fluids in.

Semi Bath – A lubrication system that uses a lubricating oil to keep the bushing surface and stanchion legs (inner legs) as friction free as possible during movement of the stanchion legs.

Spring Rate – The rate at which the resistance of a spring increases as it is compressed.

SPV – (Stable Platform Valve) new damping system that allows the rider to set the pedaling platform that he desires to pedal most efficiently in all situations. It is dependent on the pressure that the SPV valve experiences from the movement of the wheel vs. the terrain and the platform that is set by pressure introduced to other side of the SPV valve through changes of air pressure working on the damping oil.

Slider/Outer Casting – The tube (outer casting leg) of the suspension fork that remains fixed to the wheel. It slides up and down on the stanchion leg (inner leg).

Stanchion Clamps - (Double-Triple Clamps) the portions of the fork crown that clamp around the stanchion legs above and below the head tube of the bicycle frame on specific long travel applications.

Stanchion Legs – The suspension tube (inner leg) fixed to the fork crown. It remains stationary during the operation of the suspension.

Steer Tube – The long cylindrical tube that extends from the top of the fork crown. Its function is to be inserted into the bicycle head tube and attach the suspension to the bicycle frame.



GLOSSARY OF TERMS (CONT.)

Thru Axle – A device used for mounting a thru axle hub to special outer legs that are not made for standard quick release hubs. Manitou's Thru Axle system is a special patented system utilizing a hex shaped end that increases the stiffness of the fork and reduces slippage in the joint between the axle clamps and the axle.

Top Out Bumper – A rubber, coil spring, or elastomer device that absorbs the shock that occurs when the load is taken off a suspension so that it is allowed to rebound to its limits

TPC – (Twin Piston Chamber) a patented damping system that has independent pistons for rebound and compression. The system utilizes a mixture of air and oil in the damping leg of the fork to enhance the damping performance.

TPC+ - A variation of TPC that has added a floating piston to the compression damper to enhance the performance of the compression damping under the load of bigger hits.

Travel – The amount that a wheel moves between the most compressed and the most extended states of the suspension

Viscosity – A description of how a liquid flows. Liquids with higher viscosity are thicker flow less easily or quickly than liquids with low viscosity. This has an affect on the damping speeds of rebound and compression.

Volume Control – A new system designed to work with SPV as a control of the compression ramp up rate of the fork. It has a range of adjustments from linear to very progressive.

Wiper Seal – A rubber material that is used as a seal to keep dirt and water out of the outer casting legs. It is not designed to keep air pressure or extreme oil pressure in. Manitou has the new Evil Genius wiper seals.

2004 Sherman Forks Disassembly and Rebuild Instructions

Disassembly Instructions

Removal of Outer Casting

WARNING This fork uses a preloaded coil spring provide spring resistance. The spring must be relieved of its preload prior to servicing. Failure to do so could result in injury or possible death.

1. On forks with Rapid Travel Adjust II (Top Travel Adjust), be sure to set travel to its longest setting. Rotate knob on top left of fork leg clockwise towards the front of the fork and then push down on the fork to release its travel into the longest mode. More complete instructions for servicing Travel Adjust systems may be found in the "Travel Adjust" section.
2. Turn the fork upside down and remove the fixing screw that attaches the Rebound Adjuster Knob (Blue). Set the knob and screw aside.
USE: 2mm Allen wrench to unscrew fixing screw.
3. Remove the 11mm Compression Rod bolt from the bottom of the left leg (From the rider's perspective).
USE: 11mm socket, nut driver, or open-end wrench.
4. Insert 8mm Allen wrench into the end of the Rebound Damper Shaft on the bottom of the right leg. Turn the wrench in a **Clock Wise** direction in order to loosen the damper shaft in the casting (See Figure below). You are turning the Damper Shaft in a way that causes it to disappear into the casting leg.

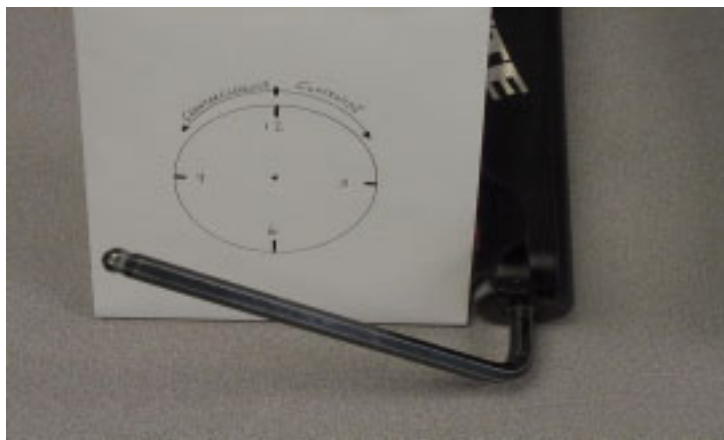

- USE:** 8mm Allen wrench
5. Working with the "Semi Bath" lubrication system:
 - A. Position the bottom of the fork legs over a drain pan that is on the ground. Pull the casting downward towards the pan, allowing the Semi Bath oil in the casting to drip into the pan. Pull the casting completely off of the inner legs and wipe any excess oil off of inner legs and inside of casting.
USE: Drainage pan and extra rags

Removal of TPC+ Compression Damping Assembly

1. Be sure to twist adjuster knob all the way clockwise to decrease damping effect on fork. Then, unscrew 2mm Allen screw from top of TPC+ adjuster knob (knob on top left stanchion leg).
2. Remove adjuster knob and unscrew remaining assembly from stanchion leg with a 20mm socket.
3. Pull assembly from leg in a twisting motion and be aware that oil that is on top of the TPC pistons will come out with the assembly. Have a rag handy.

Removal of SPV Compression Damping Assembly

WARNING This fork uses compressed air as part of the SPV damping system and must be relieved of pressure prior to servicing. Failure to relieve air pressure could result in injury or possible death.

1. Remove Schrader valve dust cap from Red Hex Shaped Top Cap on the top right of the crown. Release all air pressure from the Schrader valve.

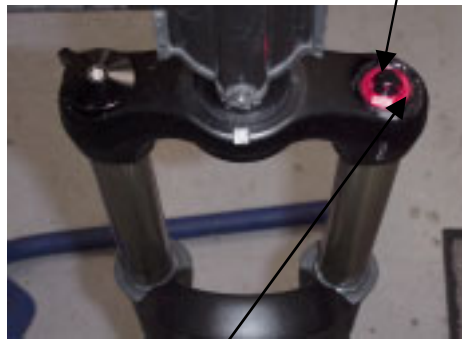

2. Remove SPV Volume Control Cap (Red Hex Shaped Top Cap) from top right of the crown with a 24mm Socket. Turn fork upside down over drainage pan to empty Damping oil from the inner leg. Stroke the Damper shaft on the bottom of the inner leg 3-5 times to purge the leg of oil that is caught below the oil piston.

USE: 24mm Socket, Valve core removal tool or small object that can be used to depress valve stem.

Removal of TPC and SPV Rebound Damping Assembly

1. Unscrew Damper end cap from the bottom of the right leg and then pull the TPC or SPV damping assembly out of inner leg. Be aware that a small amount of damping oil will come out with the assembly. This oil is the oil that is trapped under the piston.



2. Checking the function of the SPV valve:
 - a. Visually inspect the gap between the SPV valve and the bottom of the damping piston. It should have approximately 1mm of space. The valve should also spring back to its open rested position after compressing it with your fingers.
*If the valve is not responsive or all the time closed, it is bad and the assembly needs to be replaced.
USE: 24mm Open-end wrench or 8-10" Adjustable wrench

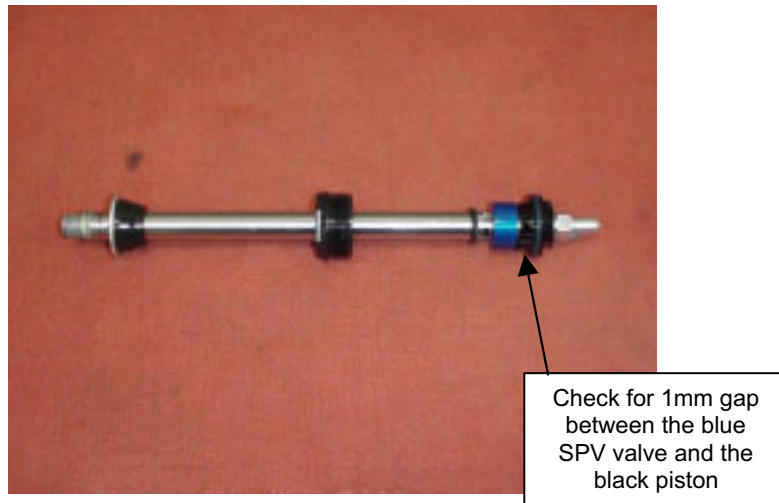

Removal of Spring and Compression Rod Assembly

WARNING This fork uses a preloaded coil spring provide spring resistance. The spring must be relieved of its preload prior to servicing. Failure to do so could result in injury or possible death.

1. **For Sherman Single Crown forks (Rapid Travel II):** Remove the adjuster knob from the top of the travel adjust assembly on the top of the crown on the left side of the fork, by unscrewing the 2mm Allen head screw. Use a 20mm socket and unscrew the remainder of the assembly from the crown. The spring will be attached to the bottom of the assembly, when you pull it from the inner leg.
2. Pull the spring from the assembly and it can be substituted with a different rated spring if necessary.

3. The compression rod assembly may be removed by unscrewing the end cap on the bottom of the left leg. After unscrewing the end cap, pull the assembly from the inner leg.
4. **For more specific details on Rapid Travel II, refer to “Travel Adjust” section of this manual.**
5. **For Sherman Dual Crown forks:** Remove the top cap from the top of the crown on the left side of the fork with a 20mm socket. The spring will be attached to the bottom of the assembly, when you pull it from the inner leg.
6. Pull the spring from the assembly and it can be substituted with a different rated spring if necessary.
7. The compression rod assembly may be removed by unscrewing the end cap on the bottom of the left leg. After unscrewing the end cap, pull the assembly from the inner leg.
USE: 24mm Open-end wrench or 8-10” Adjustable wrench,
2mm Allen wrench, 20mm socket
(Note: If you are going to change the spring without taking the entire fork apart, you must first unscrew the compression rod on the bottom of the left fork leg. Now you may unscrew the top cap and remove it and the spring. It may be necessary to exert extra force when pulling the spring out of the leg.)

Bushing Removal & Installation

Please refer to section on Bushing Removal & Installation.

Rapid Travel II Service Instructions

Disassembly:

WARNING This fork uses a preloaded coil spring provide spring resistance. The spring must be relieved of its preload prior to servicing. Failure to do so could result in injury or possible death.

1. Make sure that fork is in long travel mode by turning T/A knob clockwise until it stops, then compress fork one time and release it into long travel.
2. Unscrew 2mm Allen Head from top of knob.
3. Unscrew top cap that is threaded into crown with 20mm socket.
4. Remove spring from inner leg.
5. From the right leg dropout, use a 2mm Allen wrench to remove rebound damper adjuster knob. Use an 8mm Allen wrench and turn the damper shaft **clockwise** until it can be pushed into the casting.
6. Remove Compression Rod bolt from the left leg dropout with a 7/16” socket or open end wrench.
7. Remove crown/steer/inner leg assembly from the outer leg casting. Be sure to drain all Semi Bath oil out of casting before re-assembly of fork.
8. Remove left leg end cap and compression rod assembly from inner leg.



Assembly:

(See Photos on Next page)

WARNING When installing the outer Leg Casting to the Crown Steer Assembly, Drop Out bolts and Damper Shafts must be properly tightened prior to use. Failure to do so could result in injury or possible death.

1. Install travel adjust compression rod assembly into inner left leg and torque end cap to 20inlbs. **Be sure to put a dab of Blue Loctite on the end cap threads before installing cap into leg.**
2. Grease spring and insert into inner leg. If spring does not go in all of the way, twist it slightly and it will fall into place. Do not force spring into leg.
3. Install top cap with 20mm socket and do not tighten it all of the way. **Be sure to put a dab of Blue Loctite on the end cap threads before installing cap into leg.**
4. Install rebound assembly, start threads by hand and then torque to 20inlbs. **Be sure to put a dab of Blue Loctite on the end cap threads before installing cap into leg.**
5. Pull out damper shaft as far as it will go.
6. Press inner legs into casting about half way and then inject Semi Bath oil (5/20wt. synthetic oil) into outer casting, holding fork at 45 degree angle to the ground with bottom of fork in the air (drop outs up). Inject **16 cc's** of oil into each outer leg. It is recommended to use a syringe to inject oil.
7. Press inner leg assembly into outer leg casting until damper shaft contacts casting.
8. Use an 8mm hex wrench to turn the damper shaft counterclockwise, threading it into the casting. Torque to 20inlbs.
9. Install rebound adjuster knob.
10. Press inner leg assembly into outer leg casting until compression rod contacts casting.
11. Install Compression rod screw, torque to 40-50inlbs.
12. Set travel adjust knob all the way clockwise, compress fork, and then release to verify that it is in longest travel.
13. Remove adjuster knob, then remove top cap with 20mm socket. Twist aluminum hex shaped shaft clockwise until you meet resistance, release shaft and let it return naturally to wherever it stops.
14. Using a marking pen, mark one side of the hex shaped shaft that is facing the front of the fork. Remember where that colored side is in relation to the crown of the fork. Install top cap and tighten to 35-50inlbs.

WARNING All top caps for Damper and Spring systems must be properly tightened prior to use. Failure to do so could result in injury or possible death.

15. Twist hex shaped shaft counterclockwise until it is in the same position that it was in before you installed top cap. Install adjuster knob so that tang of knob is all the way clockwise and then tighten 2mm Allen screw until tight.
16. Compress fork and it should be in long travel and plush. Twist knob all the way in the other direction (towards the arch of the fork) and compress fork. You should hear the Travel adjust mechanism engage and the travel will now be shorter.



Top Travel Adjust Components

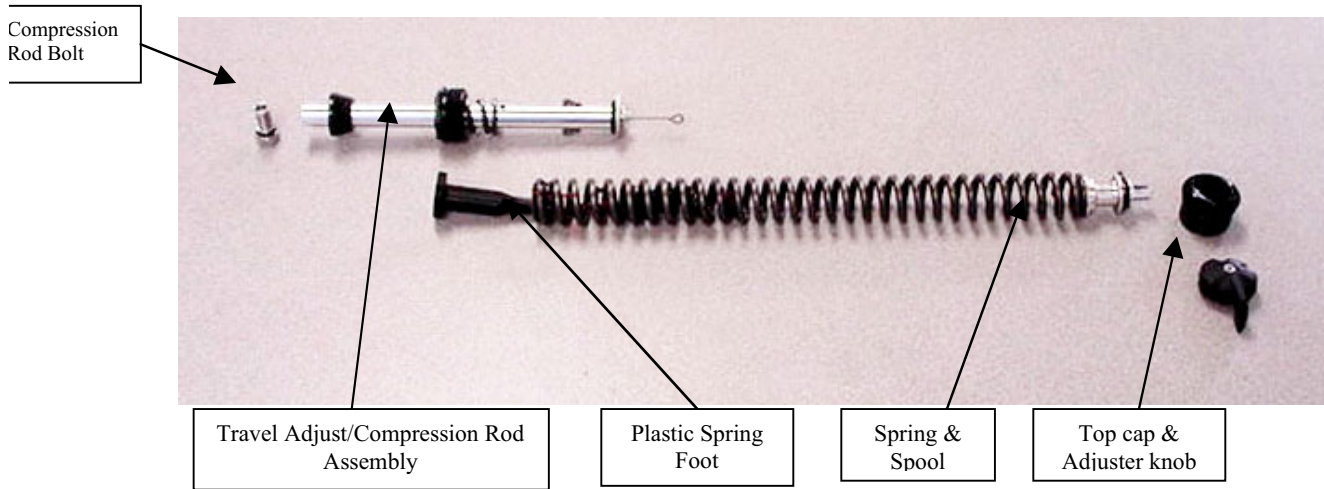

Removal & Installation of Adjuster Knob

Removal & Installation of top cap





Twisting Hex
Shaft in order
to clock
assembly

Assembly of Crown Steer/Leg Assembly

Sherman Single Crown forks

(Note: Apply a small dab of Blue Loctite on all top cap and leg end cap threads before reinstalling them in fork.)

1. Make note of which is the right leg of the crown/steer/leg assembly (**fork serial # is etched into the back of the right crown of the fork, from the rider's perspective**) and which leg is the left one. Turn the assembly upside down, so that the bottoms of the inner legs are facing you. In the left leg; insert the Travel adjust compression rod assembly, and tighten end cap into leg. Tighten to torque values that are listed on fork schematic.

WARNING All leg caps for Damper and Spring systems must be properly tightened prior to use. Failure to do so could result in injury or possible death.

2. Now, install SPV rebound damping assembly or TPC rebound damping assembly into bottom of other inner leg. Be sure to check the function of the SPV valve and apply a thin layer of Prep M grease onto o-ring that is around the piston at top of assembly. Install the assembly and tighten end cap to specified torque value.



Check for 1mm gap between Blue SPV valve and Black piston. If there is no gap, assembly needs to be replaced.

3. Turn Crown/steer/leg assembly right side up, so that the crown of the assembly is facing you. Extend the SPV rebound damping assembly or TPC rebound damping assembly all the way out and then pour damping oil (P/N: 85-0023) into the right inner leg. Fill leg about $\frac{1}{2}$ of the way up. Take a rag and cover the top of the right inner leg and then stroke the SPV damping assembly up and down about 5 times. This will insure that oil gets below the piston and not create an air space. Extend the damping assembly all the way out and then fill the inner leg to the specified oil level.

WARNING All top caps for Damper and Spring systems must be properly tightened prior to use. Failure to do so could result in injury or possible death.

4. Insert the Volume control assembly or TPC+ compression damping assembly into the top of the right inner leg and tighten it to specified torque value. Be sure that you unscrew the red 16mm Hex shaped Volume control nut all of the way counterclockwise after you tighten the entire assembly into the inner leg.
5. Insert spring into the top of the left leg and follow procedure in "Rapid Travel II" service instructions for clocking the travel adjust.

Use: 8-10" adjustable wrench, Manitou Volume Control Adjuster (P/N: 85-3007), 24mm socket, metric ruler

Sherman Dual Crown forks

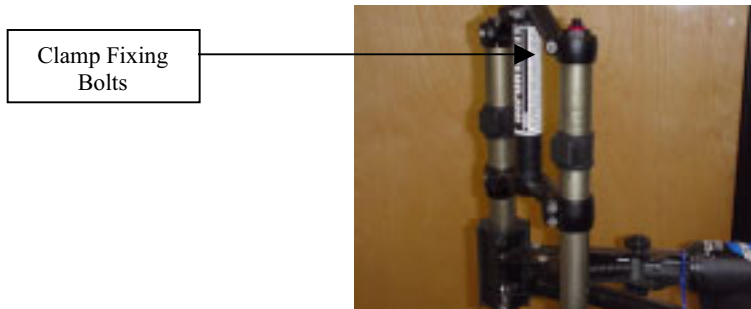

1. **Removal of inner legs from Dual Clamps:**
Loosen upper clamp fixing bolts with a 4mm Allen wrench and remove upper clamp from inner legs.
Loosen lower clamp fixing bolts with a 4mm Allen wrench and remove lower clamp from inner legs. You may have to remove the frame bumpers first to remove the lower clamp.
2. **Installation of inner legs into Dual Clamps:**

WARNING All Triple Clamp Pinch Bolts must be properly tightened prior to use. Failure to do so could result in injury or possible death.

Insert inner legs into lower clamp about 5 inches (125mm).

Install upper clamp onto the inner legs and steer tube, so that the top of the upper clamp is flush with the top of the inner legs. Do not tighten fixing bolts at this time, because you will have to make adjustments to the distance between the clamps before you install the fork on your bike.

3. Install SPV rebound damping assembly or TPC rebound damping assembly into bottom of right inner leg. Be sure to check the function of the SPV valve and apply a thin layer of Prep M grease onto o-ring that is around the piston at top of assembly. Install the assembly and tighten end cap to specified torque value. **Be sure to put a dab of Blue Loctite on the end cap threads before installing cap into leg.**

WARNING All leg caps for Damper and Spring systems must be properly tightened prior to use. Failure to do so could result in injury or possible death.

4. Install compression rod assembly into bottom of left inner leg and tighten to specified torque value. **Be sure to put a dab of Blue Loctite on the end cap threads before installing cap into leg.**
5. Turn Crown/steer/leg assembly right side up, so that the crown of the assembly is facing you. Extend the SPV rebound damping assembly or TPC rebound damping assembly all the way out and then pour damping oil (P/N: 85-0023) into the right inner leg. Fill leg about $\frac{1}{2}$ of the way up. Take a rag and cover the top of the right inner leg and then stroke the SPV damping assembly up and down about 5 times. This will insure that oil gets below the piston and not create an air space. Extend the damping assembly all the way out and then fill the inner leg to the specified oil level.
6. Insert the Volume control assembly or TPC+ compression damping assembly into the top of the right inner leg and tighten it to specified torque value. Be sure that you unscrew the red 16mm Hex shaped Volume control nut all of the way counterclockwise after you tighten the entire assembly into the inner leg.

WARNING All top caps for Damper and Spring systems must be properly tightened prior to use. Failure to do so could result in injury or possible death.

7. Insert spring into top of left leg followed by top cap. Tighten top cap to specified torque value.

Setting Dual Crown Fork Ride Height

1. When setting the ride height for your fork, make this calculation to determine the lowest point at which you can set the lower clamp without it interfering the casting's arch on full compression: **Travel of fork + 20mm.**

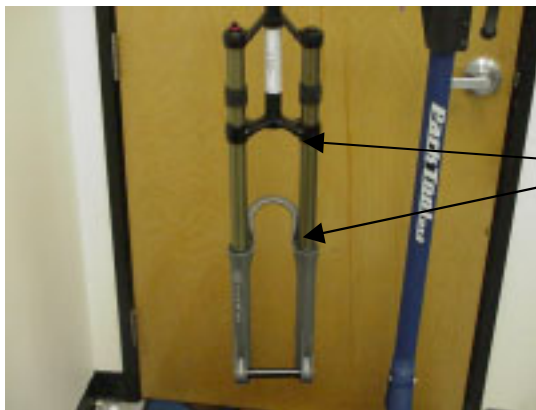

2. The number that you calculate will be measured from the top of the dust seal on the casting to the bottom of the lower clamp.

Warning: Do not set the lower crown lower than the measurement that you calculated for fear of interference with brake arch.

Installation of Hex Thru Axle

1. Hold wheel between drop outs. Insert Hex Thru Axle into the outside of the left

- Drop out (as you are facing fork) and push it through the hub of the wheel into the right drop out.
2. Thread Thru Axle nut into the end of the axle that is in the right drop out. Thread in half Way.
 3. Set the end of the axle flush with the outside of the left drop out and tighten the 3mm clamp fixing bolts to specified torque value as called out in “**Slider/Slider + Fastener Torque and Set up Values**” at end of manual.
 4. Finish the installation by tightening axle nut to specified torque value and then tighten the clamp fixing bolts on the right drop out to the specified torque.
(see photo below)

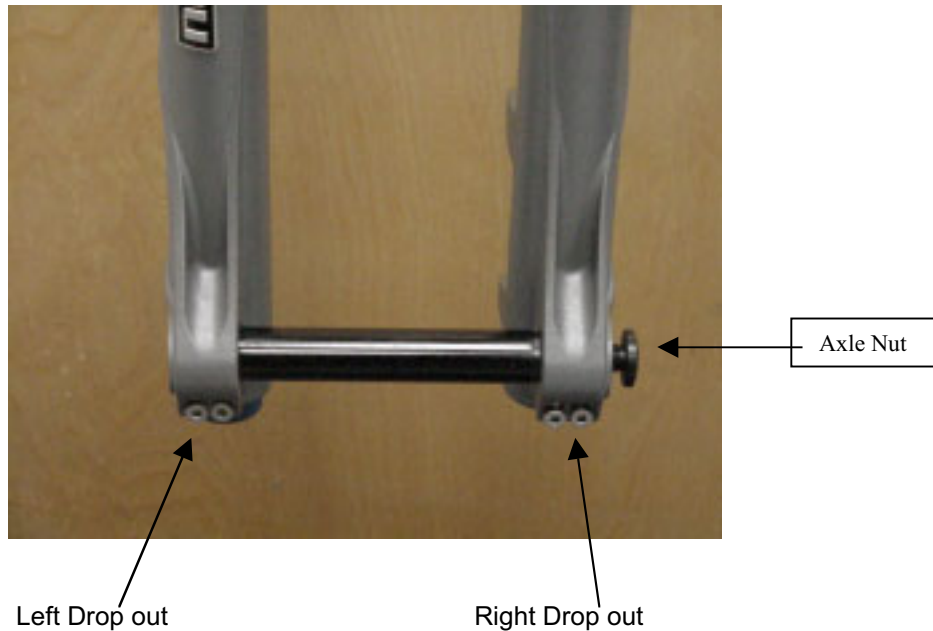

Installation of Outer Casting

WARNING When installing the outer Leg Casting to the Crown Steer Assembly, Drop Out bolts and Damper Shafts must be properly tightened prior to use. Failure to do so could result in injury or possible death.

1. Turn completed crown/steer/leg assembly upside down, so that the compression rod and SPV damper shaft are facing you. You will see a bottom out bumper on the SPV or TPC damper shaft; slide this bumper down towards the end cap that is threaded into the inner leg. This will help in keeping the shaft extended as you install the outer casting. On SPV equipped forks, you could also insert air into the damper leg through the Schrader valve on top of the right leg. This extra pressure will help to keep the shaft from moving.
2. Press inner legs into casting about half way and then inject Semi Bath oil (5/40wt. synthetic oil, P/N: 85-0022) into outer casting, holding fork at 45 degree angle to the ground with bottom of fork in the air (drop outs up). Inject **16cc's** of oil into each outer leg. It is recommended to use a syringe to inject oil (Figure 1).
3. Press inner leg assembly into outer leg casting until damper shaft contacts casting. (It is recommended to extend rebound damper out from end cap as far as it will go and then slide bottom out bumper towards the end cap as far as it will go. The bumper will help to hold the damper shaft in place as you are inserting the inner legs into the casting). Use an 8mm hex

wrench to turn the damper shaft **counterclockwise**, threading it into the casting. Tighten to specified torque values.

4. Install rebound adjuster knob. Knob should turn uninhibited until the indicator is stopped by the casting. If not, remove knob and reinstall on hex shaft in 1/6 turn increments until full travel is reached.

5. Install the compression rod screw and tighten to specified torque values.

Use: 8mm Allen wrench, 2mm Allen wrench, 11mm nut driver or open end wrench, syringe for Semi Bath oil.

Figure 1

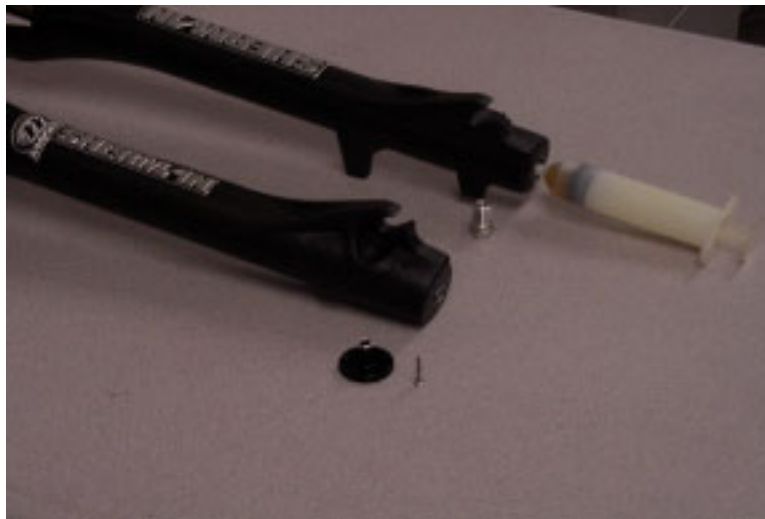



Adding Semi Bath oil to a casting
with Syringe

Bushing Removal & Installation

Bushing Removal

(Note: use appropriate removal ring that corresponds to the leg diameter of the fork being repaired)

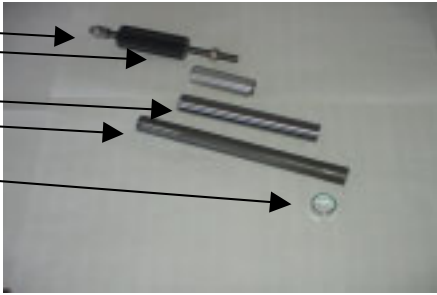
<u>Leg Diameter</u>	<u>Answer Kit #</u>
25.4mm (1")	85-5191
28.6mm (1 1/8")	85-5189
30mm	85-5194
32mm	85-5192

<p><u>Bushing Removal Tool Components</u></p> <ul style="list-style-type: none"> A. Slide Hammer B. Threaded Handle C. Slide D. Threaded Shaft E. Removal Ring 	
<p><u>Bushing Removal Tool Assembly</u></p>	

Bushing Removal (CONT.)

Bushing Removal Instructions

- A. Install 25.4mm Removal ring on the shiny, smaller diameter threaded shaft. Be sure to install the ring with the tapered, chamfered end first, followed by the long slide tube. This tapered end leads the tool through the bushing.
- B. Start the procedure by removing the Dust/Wiper seal with a screwdriver, prying it out.
- C. Insert Removal tool past the upper bushing and then stop. It is important to pull one bushing out at a time. Push the slide on the threaded shaft down towards the removal ring. Hold the casting with one hand and the slide hammer with your other hand. Now move the slide hammer in a motion away from the casting and repeat this action until the bushing comes out.
- D. For all other leg diameters: use the larger diameter (dark colored) threaded shaft and repeat steps A-C.



Bushing Installation



(Note: Sizer kits listed in above chart contain the sizers needed for each specific leg diameter.)

Bushing Installation Tool Components

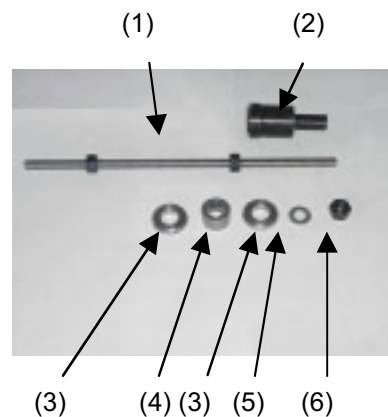
1. Installation Mandrel
2. Threaded Rod w/nuts
3. Sizer rings
4. Spacer
5. Washer
6. Nut



Bushing Installation (CONT.)

<p><i>Bushing Installation Tool Assembly</i> With weighted handle</p>	
<p>When selecting sizer rings to install bushings, choose the two rings that are in the middle of the size run to start with.</p> <ol style="list-style-type: none">1. Assemble installation tool as shown in picture above. Each leg diameter kit has all of the needed pieces to remove and install bushings for forks with serviceable bushings. Some of the kits come with gauges to tell you how far to drive in the lower bushings. Upper bushings are driven in as far as the stop in the top of the casting will allow. The general rule of thumb is that the lower bushings must not be driven any deeper than 5" into a casting leg. If they do go deeper, call Customer Service at Answer Products – 800-423-0273 for a new outer casting.2. Always assemble Mandrel with the larger diameter sizer ring being placed on the mandrel first, then the spacer, the next largest sizer ring, followed by the washer and the nut to hold it in place. Be sure to lock the nut above the Mandrel and below the Mandrel against each other.	
<ol style="list-style-type: none">3. Replace the lower bushing (bushing with a thicker wall diameter) first. Place a small amount of Prep M grease onto the sizer rings to help the rings come through the bushings when pulling them out. Slide bushing onto Mandrel until it stops. Apply a bead of Red Loctite all the way around the outside of the bushing. Hold casting on top of bench with a rag under the end of the legs and insert installation tool with bushing into casting leg.	

Bushing Installation (CONT.)

4. Slide weighted handle onto end of threaded rod and tap rod into casting with rubber Mallet until proper depth is achieved. If using depth gage, slide gage onto rod before installing weighted handle and let it settle on of Mandrel. Tap rod until appropriate line on gage is even with top of casting leg.
5. Remove weighted handle and gage (if applicable).
6. For sizing of the lower bushing:
7. Use slotted top cap from sizer kit and set it into the top of the casting leg, straddling the threaded rod. Spin the extra nut with washer down to the top cap and using a wrench, socket, or speeder wrench, tighten the nut in a clockwise direction. This will cause the Mandrel to be pulled through the bushing, thus sizing it. Keep turning the nut until the tool is all the way through the bushing and can be pulled out of the leg.
8. To install top bushings, repeat steps B-E. Note that the top bushing gets inserted until it stops against the step inside of the casting. The extra sleeve that comes with the sizer kit is used to space the top cap off of the casting, so that there is enough room to pull the sizers out of the casting without bottoming on the cap.
9. If you find that the bushings are too tight after installing them, use the sizer Mandrel that does not have a stop on it to hold the bushing while installing it into the casting. This is available in the 25.4mm leg kit (85-5191) to go back in and resize the bushings.
10. To resize bushings, Choose the next larger size rings and repeat the above process.
11. When satisfied with the results, reinstall Dust/wiper seals and then reassemble fork



TROUBLESHOOTING

Symptom	Cause	Solution	Service Manual Page
Air Loss	Schrader Valve leaks	Tighten Valve core, replace bad parts as needed.	
	Air Cap O-ring leaks	Make sure O-ring is seated properly, replace parts as needed.	
	Air Piston leaks	Check oil volume on top of piston, replace parts as needed.	
	Air Top Cap leaks	Check O-ring, tighten cap to proper Torque, replace parts as needed.	
Oil leaks from Wiper Seals	Seal not seated properly	Remove Casting from Inner Legs, reinstall or replace seals	
	Nicks or scratches on inner legs	Replace Crown/Steerer/Inner Leg Assembly	
	Too much Semi Bath oil	Follow instructions for removal and installation of Outer Casting	
	Wear	Remove Casting from Inner Legs, reinstall or replace seals	
Oil leaks from bottom of Casting	Rebound damper shaft leaks	Replace Rebound Damping assembly	
	Rebound damper shaft O-ring damaged	Replace O-ring on threaded end of Rebound Damping assembly	
	Compression Rod Bolt leaks	Check O-ring on bolt to see if it is damaged and then reinstall	
Lack of Travel	Tight Bushings	Resize bushings or replace with new ones if damaged	
	Hydraulic lock out	Replace Rebound Damping assembly	
	Semi Bath oil volume	Follow instructions for removal and installation of Outer Casting	
	Damper oil volume	Check oil level, Replace Rebound Damping assembly if needed	
	Fork alignment	Visually inspect fork, call Answer Products Customer Service	
Loss of SPV damping	SPV valve not functioning	Inspect for damage, check valve gap, replace assembly if needed	
	Damper oil volume	Check oil level, refer to "Oil leaks from bottom of Casting"	
	Rebound knob does not turn	Replace Rebound Damping Assembly	
	Loss of SPV air pressure	Refer to "Air Loss- Schrader valve leaks and Air Cap O-ring Leaks"	



TROUBLESHOOTING (CONT.)

Symptom	Cause	Solution	Service Manual Page
Fork Top out	Loss of Rebound Damping	Replace Rebound Damping assembly	
	SPV Valve not functioning	Refer to " Loss of SPV Damping - SPV valve not functioning"	
	Top out spring damaged	Inspect and replace Top out spring if needed.	
	Damping oil volume not correct	Check oil level, Replace Rebound Damping assembly if needed	
Fork Bottom out	Too much SAG	Refer to SAG Set up in Tuning section of Owners Manual	
	Bottom out Bumper damaged	Inspect and replace Bottom out Bumper if needed	
	Damping oil volume not correct	Check oil level, Replace Rebound Damping assembly if needed	
Play in Fork	Loose bushings	Resize bushings or replace with new ones if damaged	
	Loose Compression Rod bolt	Tighten bolt to specified torque	
	Loose Rebound damping shaft	Tighten Shaft to specified torque	
	Loose press fit tolerances	Call Answer Products Customer Service	



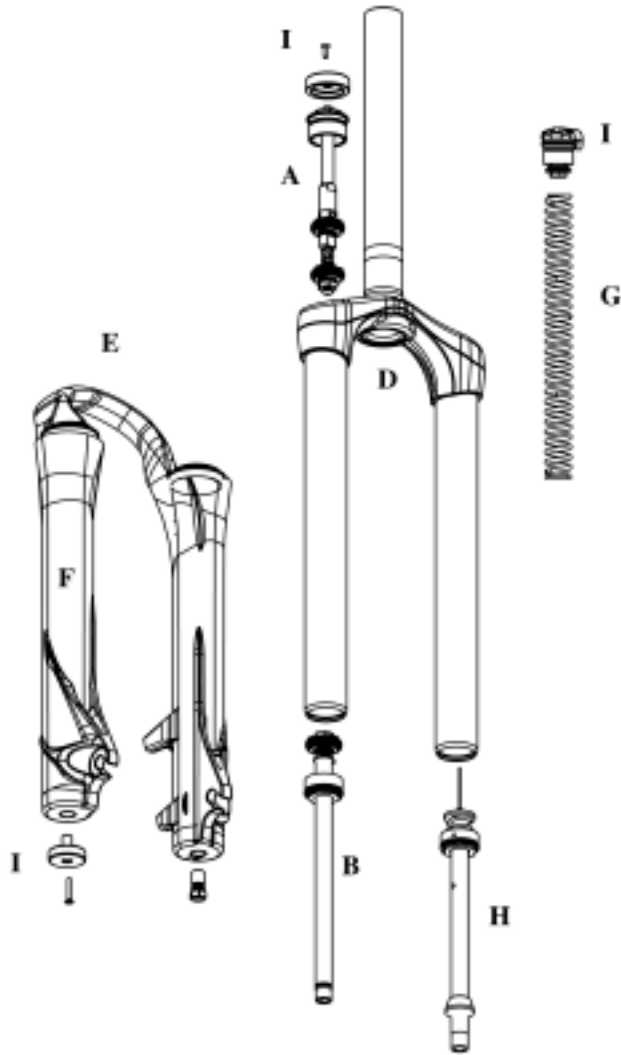

Model: Sherman Flick	
Description	Torque Value
Bushing Depth Left/Right Lower	3.9 - 4.1in., 99 - 104mm
Bushing Depth Left/Right Lower (Plus only)	3.4 - 3.6in., 86 - 91mm
Leg Caps - Not Cross-Threaded	25 - 35inlbs (2.8-4.0nm)
Torque - Damper Screw	10-30inlbs (1.1-3.4nm)
Torque - Top Travel Adjust Comp Rod Screw	45-60inlbs (5.1-6.8nm)
Torque - TA II Top Cap	35 - 50inlbs (4.0-5.7nm)
Torque - Comp Rod Screw	10-30inlbs (1.1-3.4nm)
Thru Axle Clamp Bolts	40-60inlbs (4.5-6.8nm)
Semi bath Oil Volume	16cc per leg
Damping Oil Level:	
****90/130mm Travel	3.3in, 85mm, 125cc





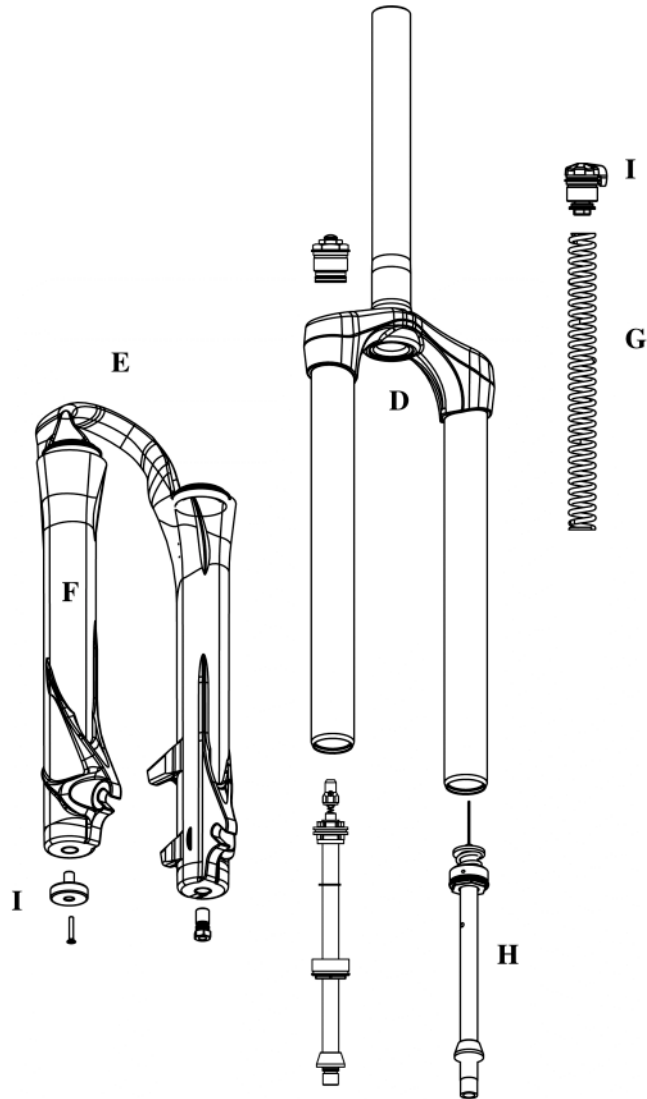

Model: Sherman Firefly	
Description	Torque Value
Bushing Depth Left/Right Lower	3.9 - 4.1in., 99 - 104mm
Bushing Depth Left/Right Lower (Plus only)	3.4 - 3.6in., 86 - 91mm
Leg Caps - Not Cross-Threaded	25 - 35inlbs (2.8-4.0nm)
Torque - Damper Screw	10-30inlbs (1.1-3.4nm)
Torque - Top Travel Adjust Comp Rod Screw	45-60inlbs (5.1-6.8nm)
Torque - TA II Top Cap	35 - 50inlbs (4.0-5.7nm)
Torque - Comp Rod Screw	10-30inlbs (1.1-3.4nm)
Thru Axle Clamp Bolts	40-60inlbs (4.5-6.8nm)
SPV Volume Control Assembly	35 - 50inlbs (4.0-5.7nm)
Semi bath Oil Volume	16cc per leg
Damping Oil Level:	
****90/130mm Travel	3.3in, 85mm, 125cc
SPV Air Pressure	40-100psi



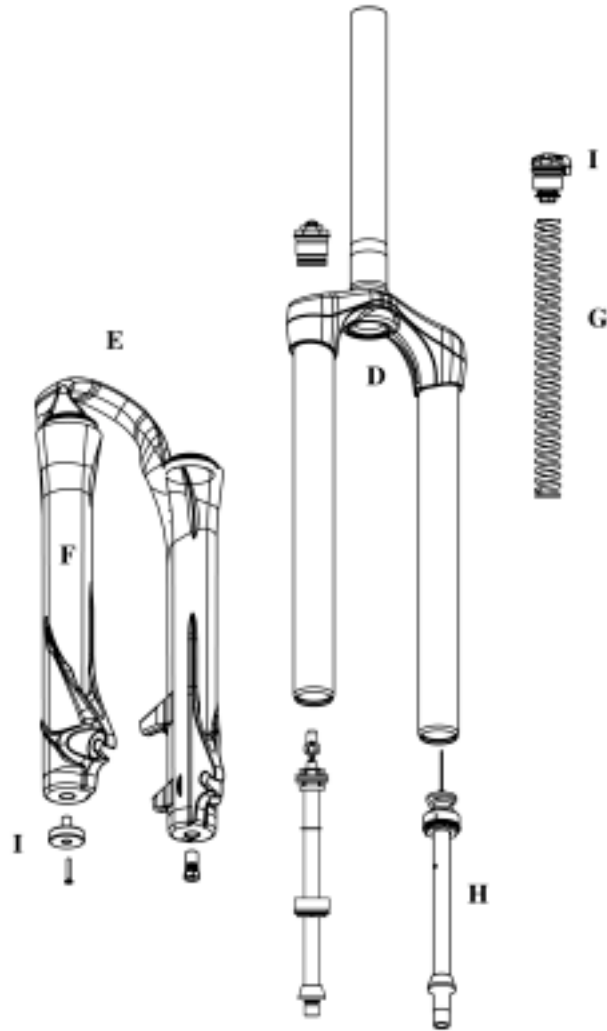

Model: Sherman Breakout/Breakout +	
Description	Torque Value
Bushing Depth Left/Right Lower	3.9 - 4.1in., 99 - 104mm
Bushing Depth Left/Right Lower (Plus only)	3.4 - 3.6in., 86 - 91mm
Leg Caps - Not Cross-Threaded	25 - 35inlbs (2.8-4.0nm)
Torque - Damper Screw	10-30inlbs (1.1-3.4nm)
Torque - Top Travel Adjust Comp Rod Screw	45-60inlbs (5.1-6.8nm)
Torque - TA II Top Cap	35 - 50inlbs (4.0-5.7nm)
Torque - Comp Rod Screw	10-30inlbs (1.1-3.4nm)
Thru Axle Clamp Bolts	40-60inlbs (4.5-6.8nm)
SPV Volume Control Assembly	35 - 50inlbs (4.0-5.7nm)
Semi bath Oil Volume	16cc per leg
Damping Oil Level:	
*****110/150mm Travel	3.7in, 95mm, 135cc
*****130/170mm Travel	4.3in, 110mm, 128cc
SPV Air Pressure	40-100psi

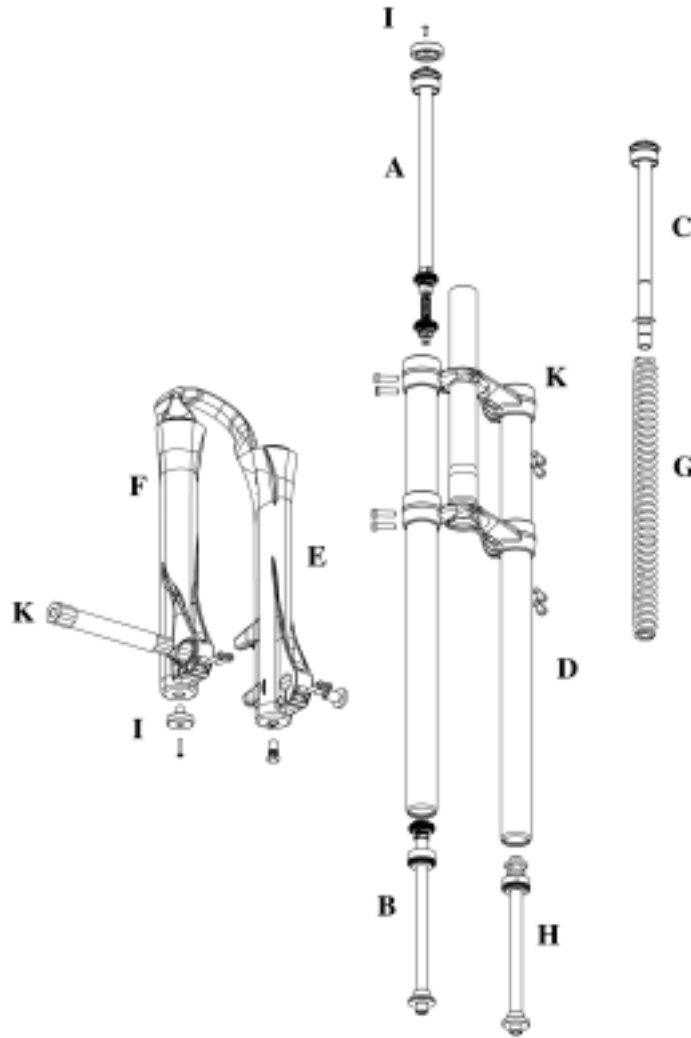

Model: Sherman Slider	
Description	Torque Value
Bushing Depth Left/Right Lower	3.9 - 4.1in., 99 - 104mm
Bushing Depth Left/Right Lower (Plus only)	3.4 - 3.6in., 86 - 91mm
Torque - Triple Clamp Bolts	80 - 90inlbs (9.0-10.2nm)
Leg Caps - Not Cross-Threaded	25 - 35inlbs (2.8-4.0nm)
Torque - Top Caps	30-50inlbs (4.0-5.7nm)
Torque - Damper Screw	10-30inlbs (1.1-3.4nm)
Torque - Comp Rod Screw	10-30inlbs (1.1-3.4nm)
Thru Axle Clamp Bolts	40-60inlbs (4.5-6.8nm)
Semi bath Oil Volume	16cc per leg
Damping Oil Level:	
*****152mm Travel	3.7in, 95mm, 135cc



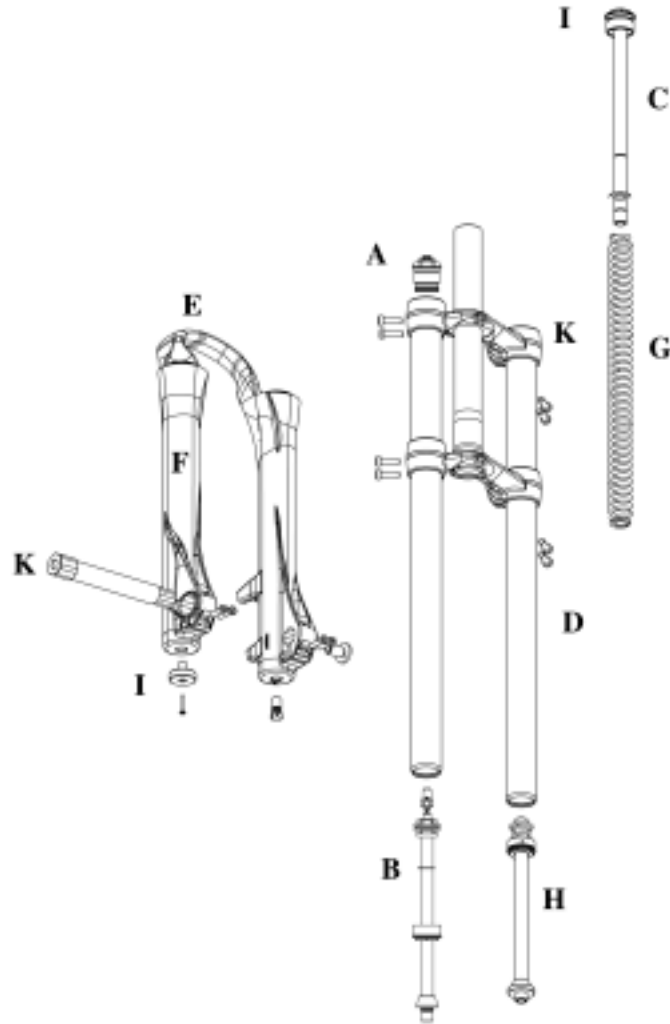

Model: Sherman Slider +	
Description	Torque Value
Bushing Depth Left/Right Lower	3.9 - 4.1in., 99 - 104mm
Bushing Depth Left/Right Lower (Plus only)	3.4 - 3.6in., 86 - 91mm
Torque - Triple Clamp Bolts	80 - 90inlbs (9.0-10.2nm)
Leg Caps - Not Cross-Threaded	25 - 35inlbs (2.8-4.0nm)
Torque - Damper Screw	10-30inlbs (1.1-3.4nm)
Torque - Comp Rod Screw	10-30inlbs (1.1-3.4nm)
Thru Axle Clamp Bolts	40-60inlbs (4.5-6.8nm)
SPV Volume Control Assembly	35 - 50inlbs (4.0-5.7nm)
Semi bath Oil Volume	16cc per leg
Damping Oil Level:	
*****170mm Travel	4.3in, 110mm, 128cc
SPV Air Pressure	40-100psi



Sherman Service Kits

Model		Flick	Flick 80	Firefly	Breakout	Breakout +	Slider	Slider +
Travel (mm)		90/130	80	90/130	110/150	130/170	152	170
Comp Damper	A	85-5897		85-5898			85-5129	85-5129
Rebound Damper	B	85-5126		85-5900			85-5126	85-5901
Pre Load Adj/Top Cap	C		85-5924				85-5960	
Crn/Str/Leg	D							
	***Steel S/T (26")	85-5091						
	***Blk AL S/T(26") STD/SM			85-5902			85-5903	
	***Blk AL S/T(26") LG						85-5962	
	***AL 1.5 S/T	85-5904			85-5905			
	***R/L Inner leg (T/C Forks)						85-5961	
	***R Inner leg (T/C SPV)							85-5963
Outer Leg Assembly	E							
STD	Textured Black	85-5161						
STD	Textured Gray	85-5162						
STD	Camo	85-5163						
No Boss	Textured Black	85-5130						
No Boss	Textured Gray	85-5131						
No Boss	Camo	85-5132						
Sticker Kit	F - Silver	85-5907						
	F - Black	85-5908						
Ride Kits	G							
	***WD Booster							
	***X-Soft				85-5909		85-5909	
	***Soft	85-5178	85-4972	85-5178	85-5910	85-5909	85-5910	85-5909
	***Medium	85-5179	85-4973	85-5183	85-5912	85-5910	85-5912	85-5910
	***Firm	85-5180	85-4974	85-5184	85-5914	85-5912	85-5914	85-5912
	***X-Firm	85-5181		85-5181		85-5916		85-5914
Travel Adjust/	H							
Comp Rod/	80		85-4491					
	152						85-5917	
	170							85-5918
	90/130	85-5919		85-5919				
	110/150				85-5921			
	130/170					85-5922		
Knob Kit	I	85-5924						
Seal Kit	K	85-5293						
Bumper Kit	K	85-5925						
O-Ring Kit	K	85-5294						
Bushing Kit	E	85-5964						
Thru Axel	E	85-5070						
Top Clamp - LG	D						85-5965	
Top Clamp - SM	D						85-5966	

